

BATTERIA ELETTRICA RISCALDANTE
 50.000 W (+/-5% a freddo) 690 V/3Ph
 2 Stadi da 25 kW
 6 Elem. lisci diam.16 mm. AISI 316L
 Flangia AISI 304 sp.5 mm. custodia IP55

ELMOT		ELMOT	
DISONNATO	G.M.	CLASSE	
CONTRATTO	G.M.	DEDENOMINAZIONE	BATTERIA RISCALDANTE
DATA		COD.	N.D/S.
SCALA			
Via E. Fermi N.36 TEL. +39 019 567 310 - 196 FAX +39 019 567 781 E-mail: elmot@riscaldi.it www.elmot.com			

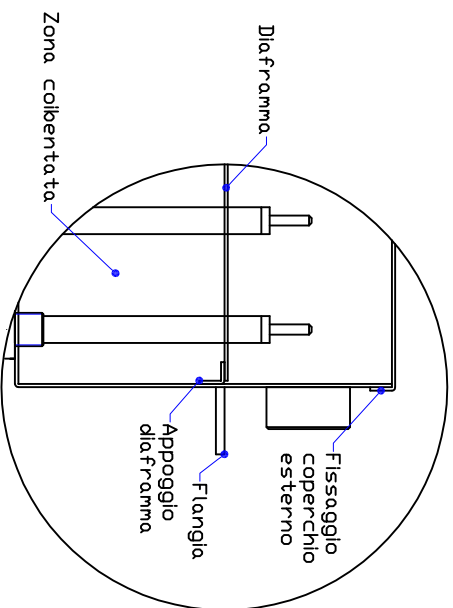
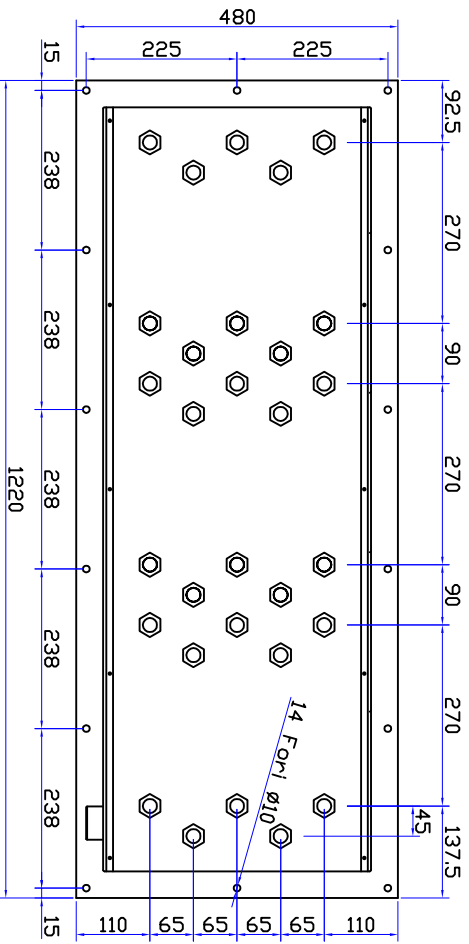
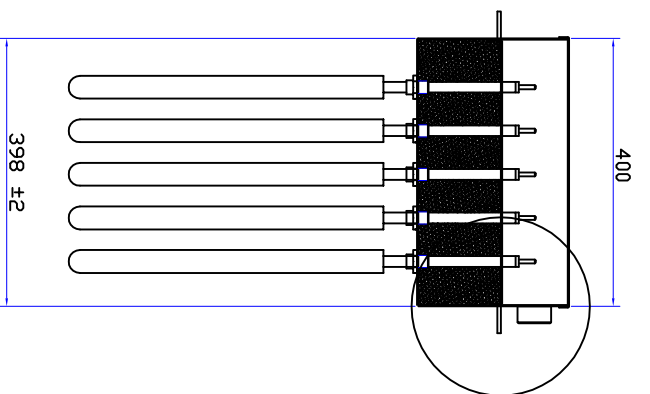
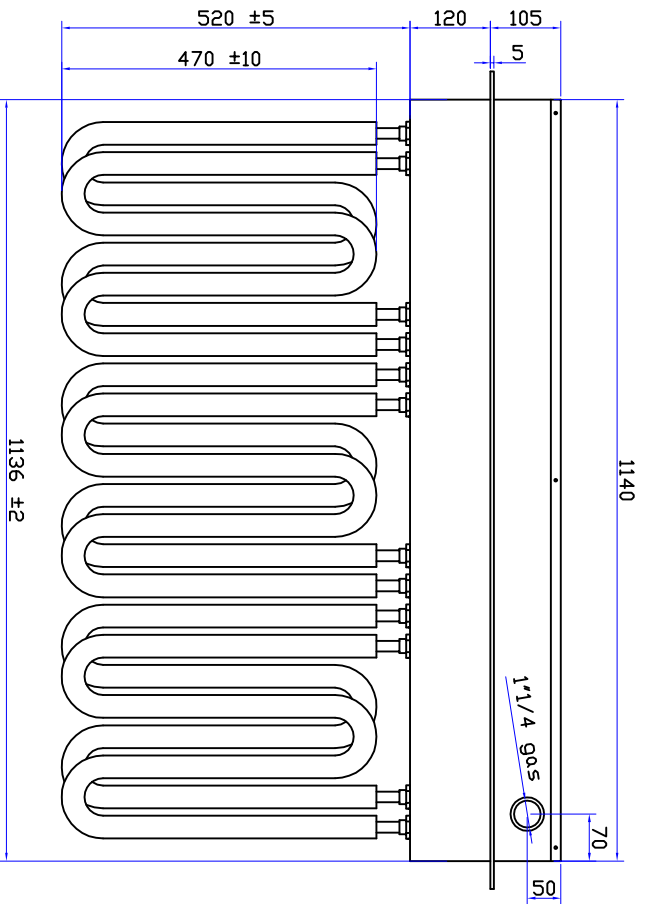

ELMITE		ELMITE	
RISCALDATORI ELETTRICI		RISCALDATORI ELETTRICI	
Avigliano TO ITALY		Avigliano TO ITALY	
COD. CLIENTE	CLIENTE	NOTE	MATERIALE
DISEGNATO G.M.	DENOMINAZIONE		Acciaio C.
CONSTATATO G.M.	BATTERIA FLANGIATA		
DATA	COD.		
SCALA	N. DIS.		

Via E. Fermi N.36 TEL. +39 011 9867 310 - 196 FAX +39 011 9867 181 E-mail: elmite@riscaldatori.com www.elmite.com

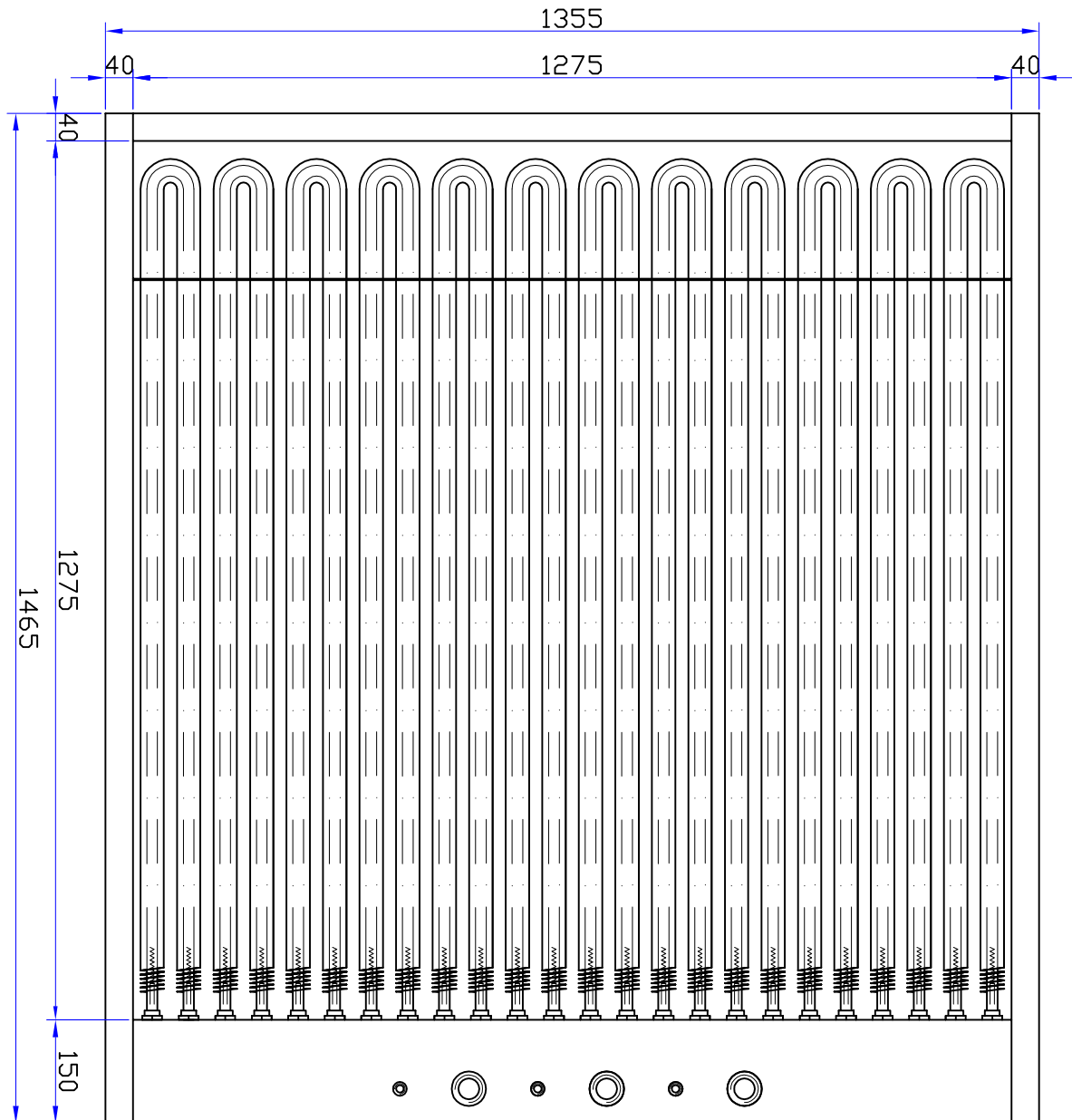
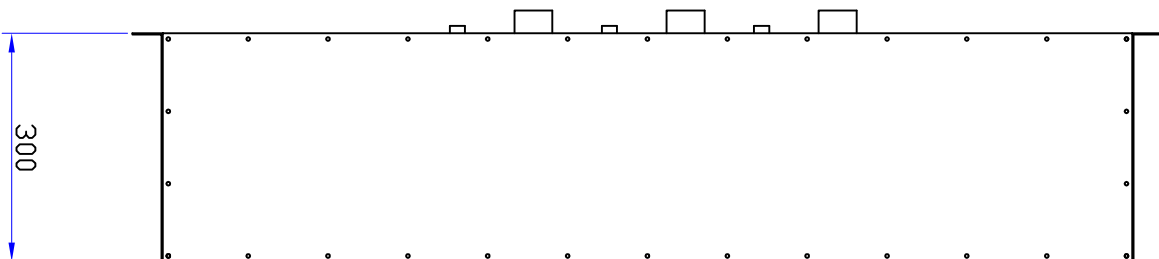

RISCALDATORI ELETTRICI
Avigliana TO ITALY

COD. CLIENTE		CLIENTE		COD. INTERNO	
DISEGNATO - A.B.		MATERIALE - ACCIAIO ZINCATO		NOTE	
CONTROLLATO		DENOMINAZIONE - BATTERIA RISCALDANTE		N. DISEGNO	
DATA					
SCALA - 1:10					

Via E. Fermi N.36 TEL. +39 0119367 310 - 196 FAX +39 0119367 181 E-mail elmh@iscad.it www.elmhi.com

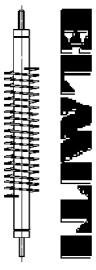
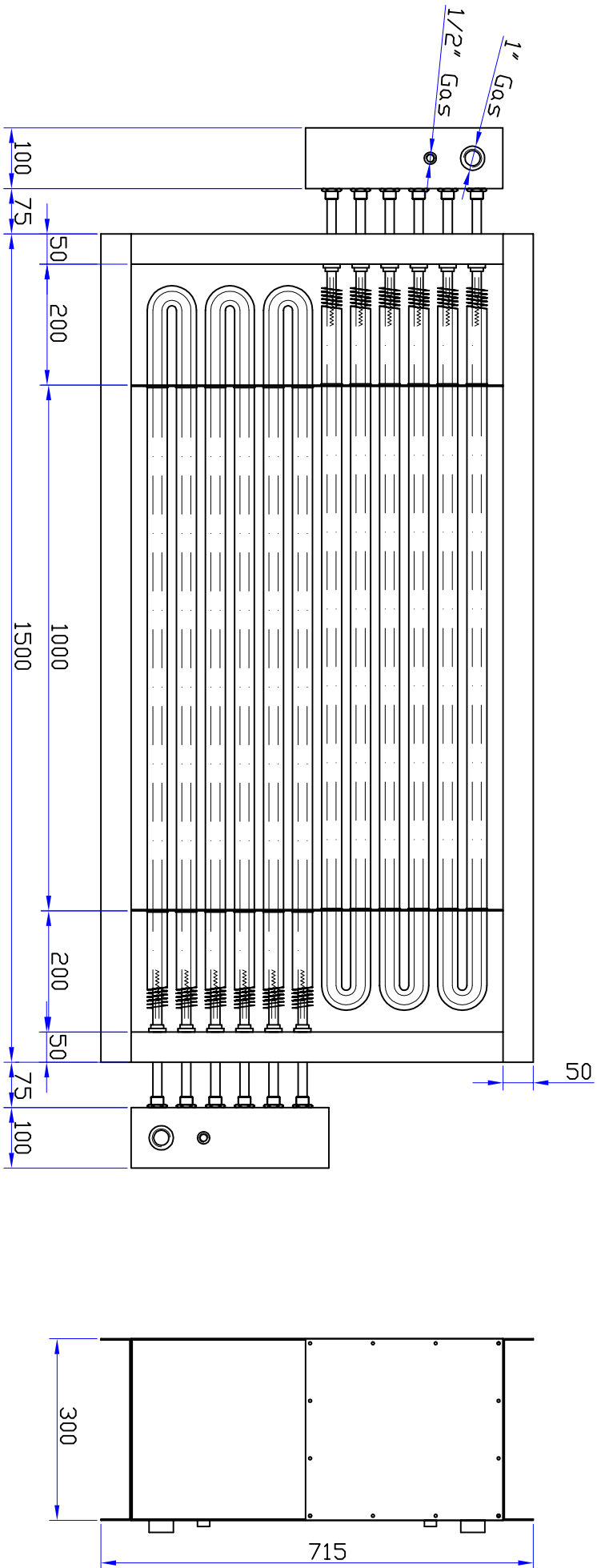

RISCALDATORI ELETTRICI
Avigliana TO ITALY

COD. CLIENTE		CLIENTE		COD. INTERNO	
DESIGNATO - A.B.		MATERIALE - AISI 321/304		NOTE -	
CONTROLLO		DENOMINAZIONE - BATTERIA RISCALDANTE		N. DISEGNO	
DATA - 11/02/2013					
SCALA					

Via E. Fermi N.36 TEL. +39 0119367 310 - 196 FAX +39 0119367 181 E-mail: chimti@riscedati.it www: chimti.com

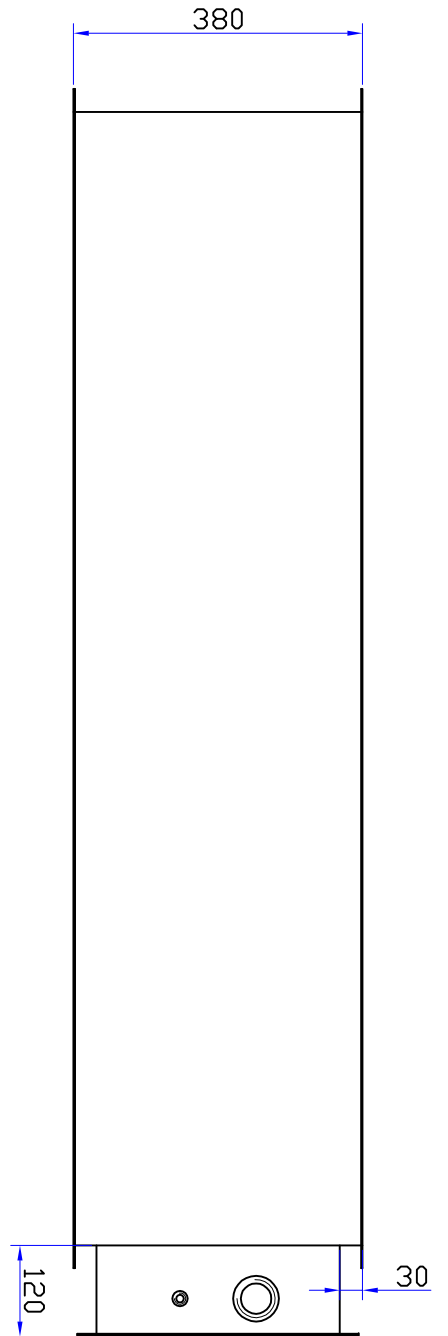
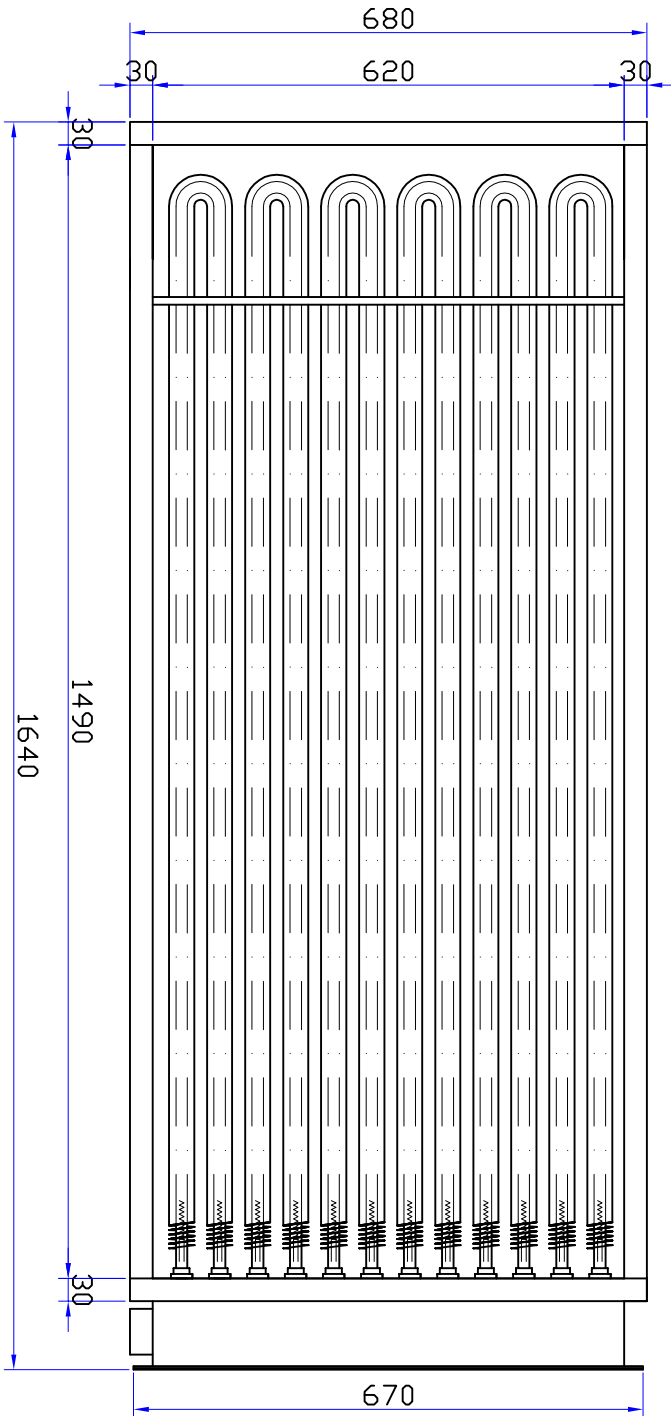
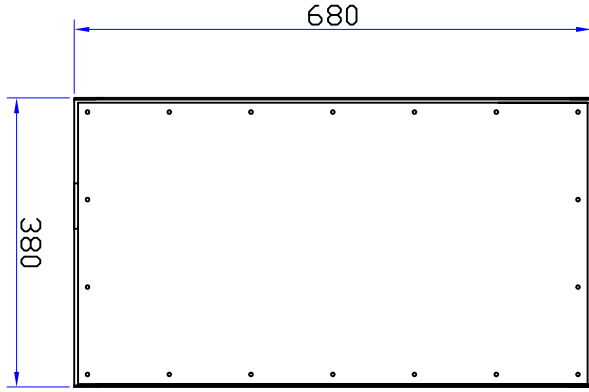

RISCALDATORI ELETTRICI
Avigliana TO ITALY

COD. CLIENTE		CLIENTE		COD. INTERNO	
DISEGNATO - A.B.		MATERIALE - ACCIAIO ZINCATO		NOTE	
CONTROLLATO		DENOMINAZIONE - BATTERIA ELETTRICA		N. DISEGNO	
DATA - 04/05/2016					
SCALA - 1:10					

Via E. Fermi N.36 TEL. +39 0119367 310 - 196 FAX +39 0119367 181 E-mail elmatti@iscald.it www.elmatti.com

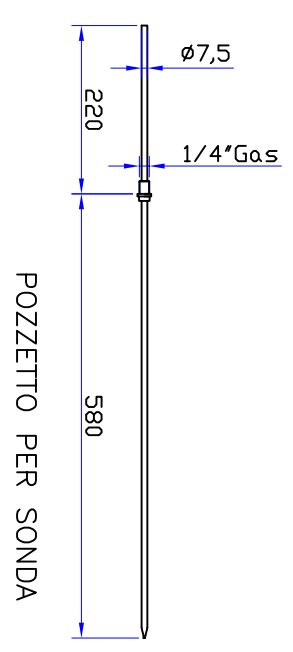
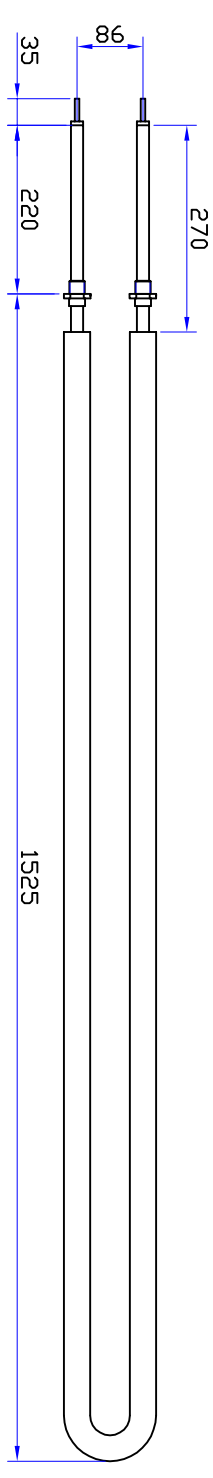
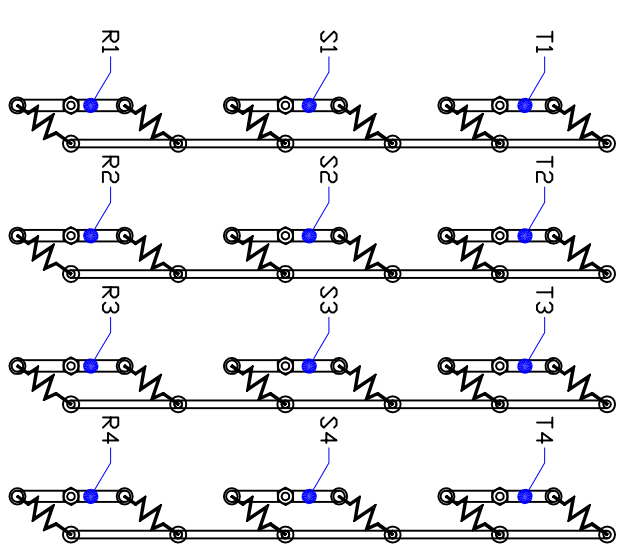
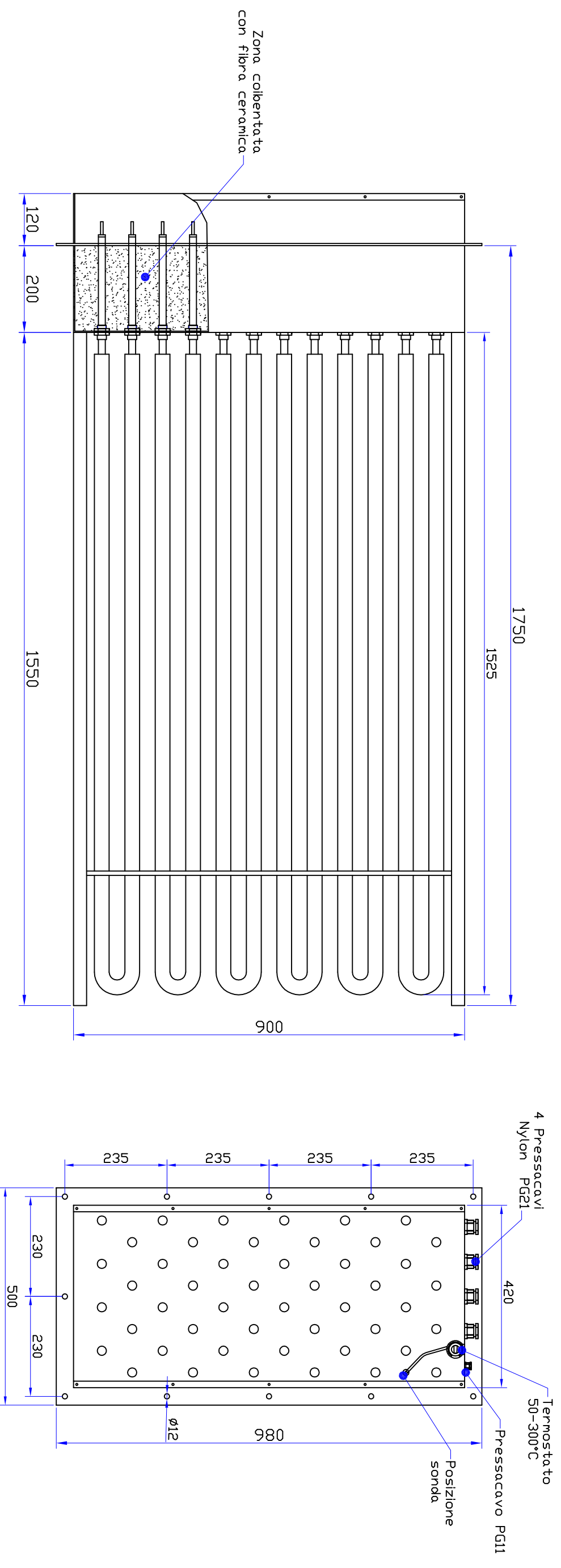

Schema di collegamento

		RISCALDATORI ELETTRICI Avigliana TO ITALY	
COD. CLIENTE	CLIENTE	DENOMINAZIONE	NOTE
DISSEGNAIO G.M.		BATTERIA RISCALDANTE	MATERIALE AlSi 321/304
CONTROLLO G.M.		COD.	N. DIS.
DATA			
SCALA NON IN SCALA			
Via E. Fermi, N.36 TEL. +39 0119367 310 - 196 FAX +39 0119367 181 E-mail: emi@iscalf.it www.emi.it.com			

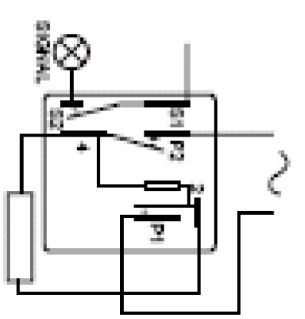
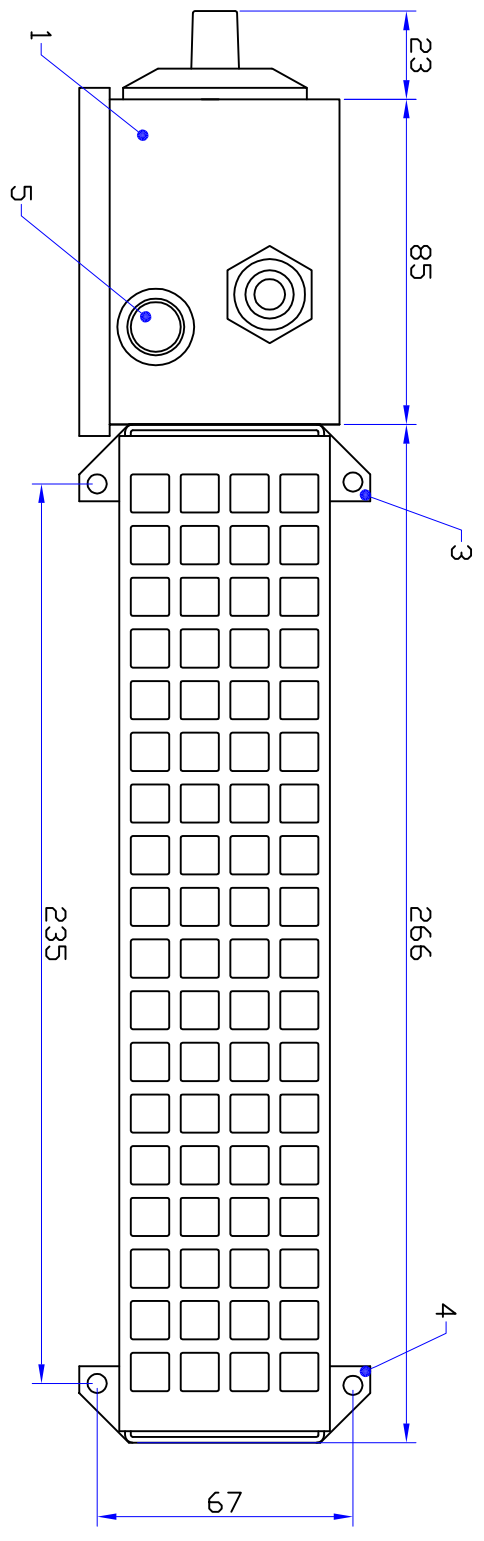
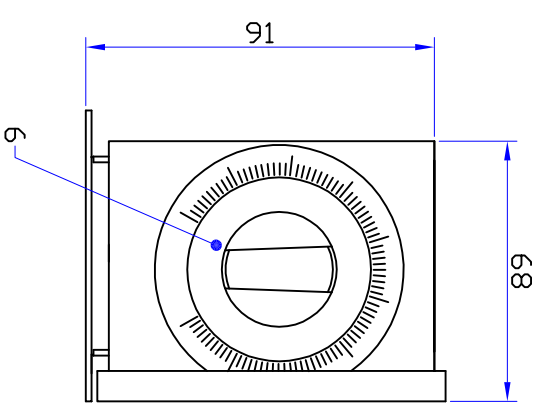
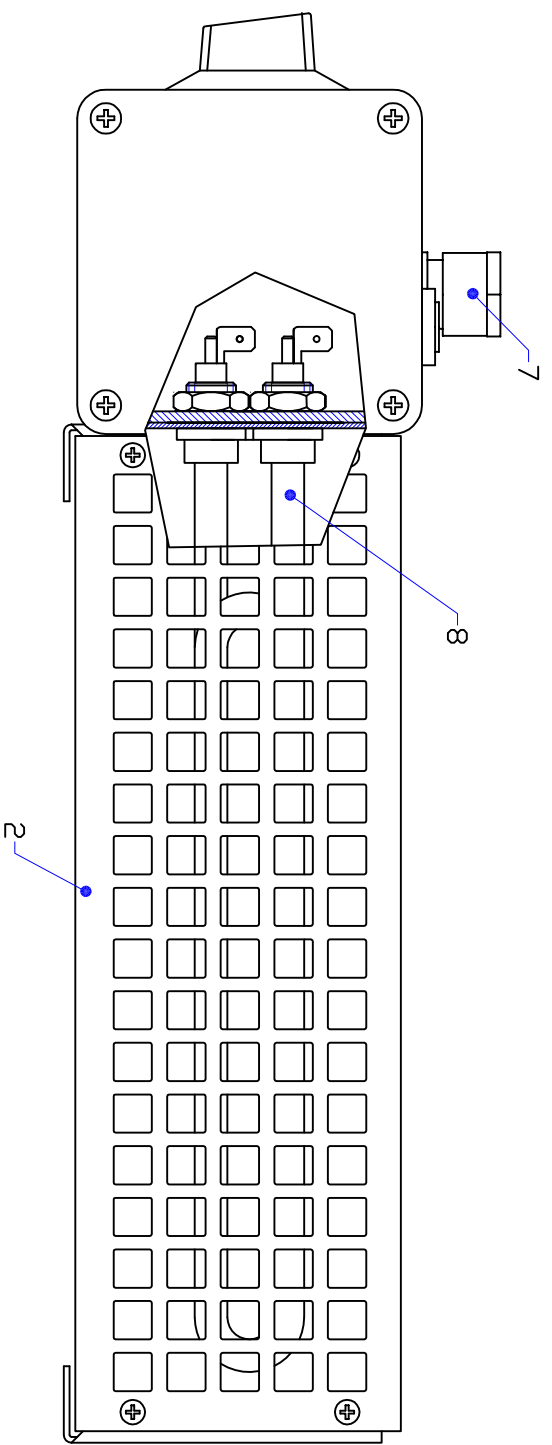

Schema di collegamento
Regolatore Diamond 45ER

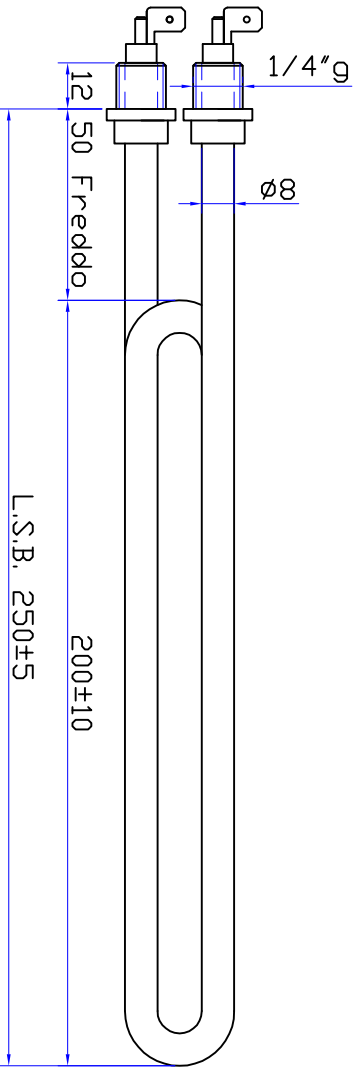

Elemento d. 8 mm. in AISI 321
400W (+/- 5% A freddo) 230V
Potenza specifica 2,0W/cm².
Cod. EG4304000950

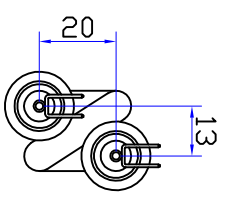

.10	-			
9	-			
8	-Elemento riscaldante 400W 230V	Nr.	.1	-EG4304000950
7	-Pressacavo PVC PG11	Nr.	.1	-
6	-Controllo di alimentazione	Nr.	.1	-Diamond 45ER
5	-Spia di funzionamento	Nr.	.1	-
4	-Predino lato chiuso	Nr.	.1	-
3	-Predino lato custodia	Nr.	.1	-
2	-Griglia di protezione	Nr.	.1	-
1	-Custodia elettrica IP55	Nr.	.1	-
RIF.	- DENOMINAZIONE	U.M.	QTA	CODICE

ELMITE
RISCALDATORI ELETTRICI
Avigliana TO ITALY

DISEGNATO G.M.
CONTROLLATO G.M.

DATA
SCALA

DENOMINAZIONE
RISCALDATORE ANTICONDENSA

COD.
N. DIS.
SCALDIGLIA 400W COMPL

NOTE:
MATERIALE

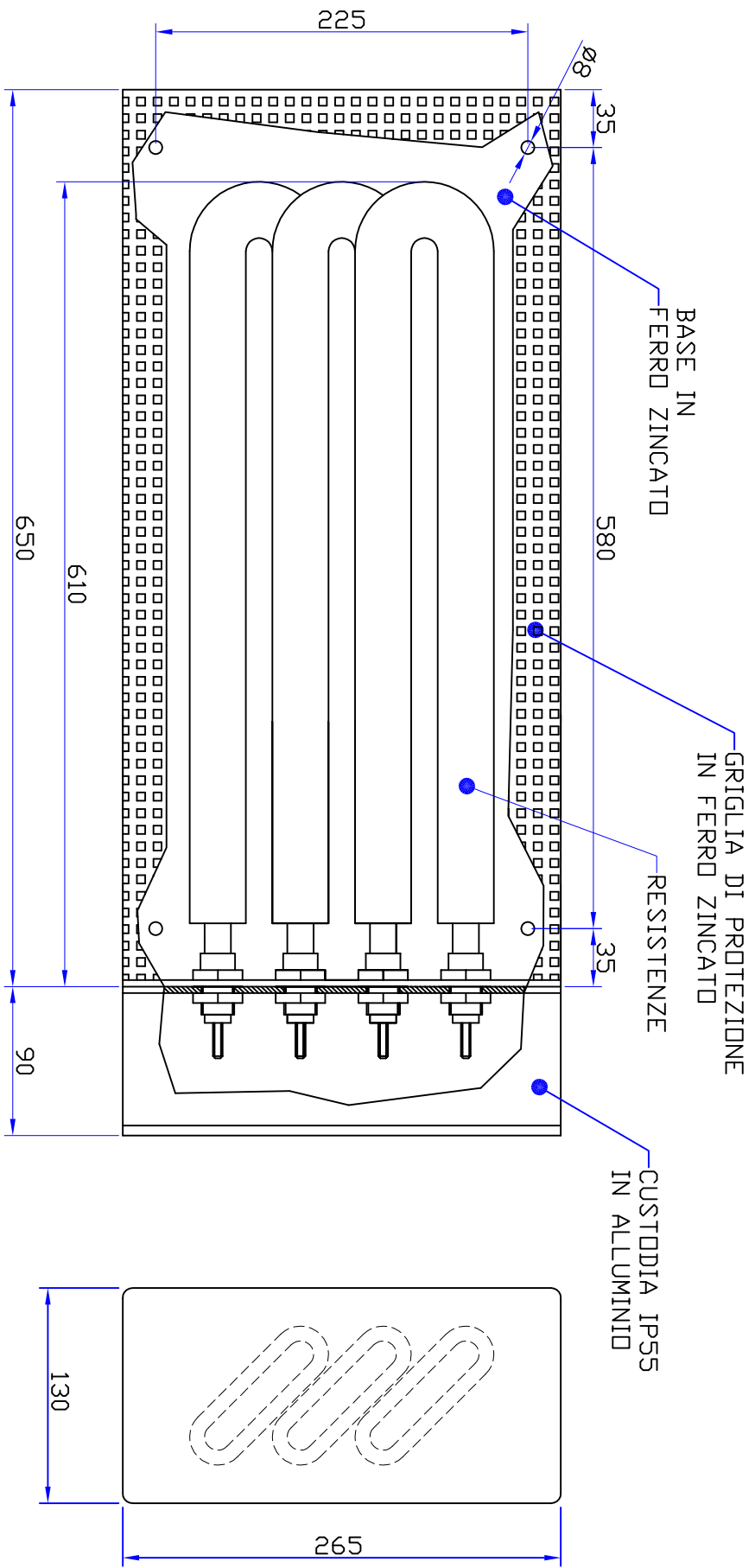

SCHEMA DI COLLEGAMENTO

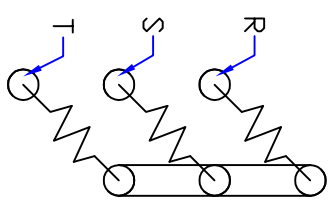

POTENZA 3600 WATT (3x1200)
 3 Elementi LOVAR 235125
 TENSIONE 400 VDLT/3Ph.

		COD. CLIENTE DISSEGNO <i>G.Messio</i>		CLIENTE		COD. INTERNO	
RISCALDATORI ELETTRICI Avigliana TO ITALY		MATERIALE FERRO ZINCATO		NOTE 3600 W 400 V/3Ph.		N. DISEGNO	
SCALDA NON IN SCALA		DENOMINAZIONE SCALDIGLIA DA PARETE					

Via E. Fermi N.36 TEL. +39 0119367 310 - 196 FAX +39 0119367 181 E-mail ehmilit@riscald.it www.ehmilit.com